



ōryōki

This pamphlet describes the oryoki, a Zen student's eating bowls. The use of oryoki during sesshin provides an opportunity for us to deepen our practice. Paying careful attention to the way in which we take our meals, our true relationship between ourselves and our food is made clear. Emphasizing each simple activity, we continually learn our way.

The sangha of Kannon Do offers this pamphlet to all practicing students. We hope you will find it useful. Feel free to reproduce as many copies as you need.

Further instructions can be found in Dogen's *Fushukuhanpo*.

ōryōki

a manual for the construction and use of eating bowls

by
Les Kaye
and the Sangha of Kannon Do
drawings by Hathaway

A monk told Joshu: "I have just entered the monastery.
Please teach me."
Joshu asked: "Have you eaten your rice porridge?"
The monk replied: "I have eaten."
Joshu said: "Then wash your bowl."

BACKGROUND

The eating bowls now in use in Zen Monasteries have been used by monks in China and Japan for over one thousand years. Called *oryoki*, these bowls are part of the Buddhist tradition of giving and non-attachment.

In Japanese, the word *Oryoki* is comprised of three symbols (Kanji):



O: the receiver's response to the offering of food



RYO: a measure, or an amount to be received



KI: the bowl.

The term *oryoki* includes not just the food-carrying vehicle, but the practice and giving of the recipient.

In early Buddhist tradition, the usual practice was for monks to obtain their daily food by begging. Begging actually existed before the Buddha's time, practiced by many religious sects, but the idea took on a larger meaning in Buddhism, where begging became an act of "offering," an exchange between layman and monk.

In Japanese, the term describing this relationship is *ogu*.

O is, as above, the receiver, the one who returns merit to the offerer with teaching and guidance.

供

The second part of the term, **GU**, is the offering itself: the food and the action of the offerer.

Ogu is a reflection of the first paramita, *Dana* (giving). The layman gives food (*gu*), the monk gives dharma. There is also another element of practice included in the term – the idea of "no clinging" – each gives to each spontaneously, "giving" and "receiving" being synonymous.

Buddhist tradition recognizes the monk's robe and bowl as representing two things most necessary to sustain life. With one, we are supported externally (clothes, shelter), with the other, internally (food). In early Buddhism, transmission of the robe and bowl was an important aspect of patriarchal succession. The items were symbolic of Buddha, and by passing them along, the patriarch emphasized Buddha's uninterrupted existence.

DESCRIPTION

Traditional Oryoki

The present day oryoki used by Zen monks consists of the following items:

1. Large "Buddha" bowl, having rounded edges
Soup is not eaten from this bowl, as it is not to be touched by the lips.
2. Four successively smaller bowls that nest into each other and into the Buddha bowl
3. A small stand on which the Buddha bowl rests
4. *Hattan*, or place mat, made from lacquered paper
5. A wooden spoon and set of chopsticks
6. A bowl cleaning stick (*setsu*)
7. A utensil holder for spoon, chopsticks, and *setsu*
8. A drying cloth
9. A napkin
10. A wrapping cloth
11. A water board (*mizuita*), used by monks as a kind of lid on their travel bag (*kesagori*) to keep out rain

Student's Oryoki

An abbreviated version of the monk's oryoki was developed in 1969 for use at Tassajara Monastery. Suzuki Roshi felt that oryoki was an important part of the student's practice, and the simplified version described in this booklet was worked out by Kobun Chino, who was the first abbot in residence at Tassajara. In addition to Tassajara, this oryoki style is in use at Zen Center in San Francisco and Green Gulch Farm in Marin County, as well as at Kannon Do.

The student's oryoki consists of the same items as the monk's oryoki with the following exceptions:

The Buddha bowl has a flat bottom and does not require a stand.

There are two smaller bowls, instead of four.

There is no *hattan* (place mat).

There is no *mizuita* (water board).

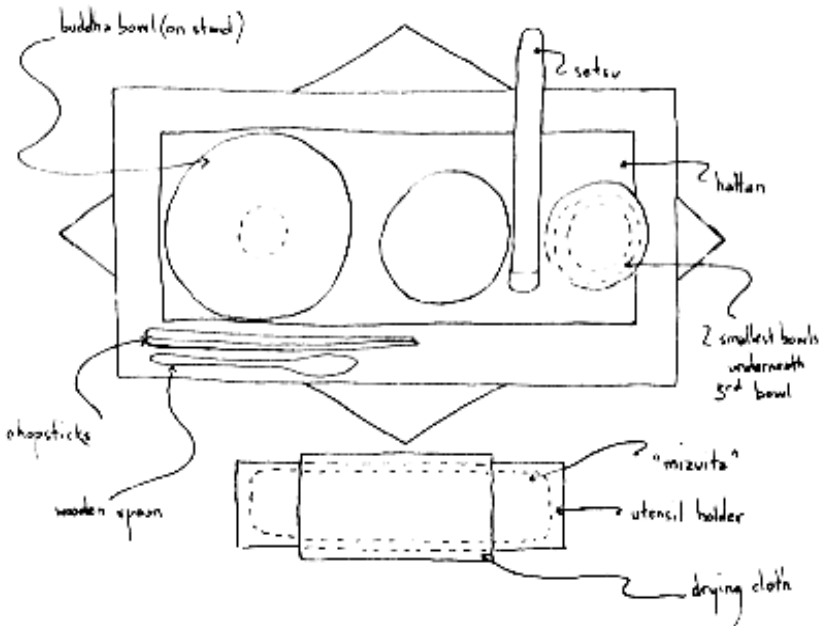

figure 1 A TRADITIONAL ORYOKI

MAKING AN ORYOKI

Bowls

Buddha Bowl

Usually a porcelain or clay bowl measuring about 6" in diameter, 2" deep (inside), and 2 1/2" top to bottom.

Second and Third Bowls

A black lacquer-ware (or plastic equivalent) covered soup dish can serve as these two bowls, with the cover being used as the shallow third bowl. Approximate dimensions: Second bowl: 4 3/4" diameter, 1 3/4" deep, 2" top to bottom. Third bowl (or cover): 4 1/2" diameter, 3/4" deep, 1" top to bottom.

Utensils

Spoon

This can be an ordinary metal kitchen spoon, but a small wooden spoon is preferred.

Chopsticks

These should be wooden, about the same length as the spoon. It is a good idea to choose a set with a flat surface to prevent rolling.

Setsu

A small rubber spatula with a wooden handle can be used as a setsu, or you can make a more traditional setsu as described on the next page.

The traditional setsu is made of wood. It is about 8 1/2" long, 1 1/8" wide at the bottom, 7/8" at the top, and about 1/8" thick. It is tapered around the edges, and both bottom and top are gently rounded. It should be finished with a water resistant coating, such as lacquer or shellac. (Any kind of scrap wood can be used. One student made a setsu from a broken yardstick.)

After making the basic setsu shape, cut a small notch on both sides, 3/4" – 7/8" from the bottom. (See *figure 2*)

Cut a piece of absorbent cloth from an old dish towel, diaper, etc., about 2" wide and long enough to wrap around twice at the base of the setsu stick. Leaving a 1/4" overhang (see diagram) is helpful when you are tucking edges under and sewing later on. Wrap the cloth around the setsu stick and tie it in place with thread, the thread passing through the notches. (*figure 3*)

Double the wrapped cloth by folding the upper half down over the lower half so that all edges are at, or just beyond, the base of the setsu stick. (*figure 4*)

Tuck in the edges at the base so that they give a neat, rolled appearance. Sew the bottom edges, as well as the side edge. (*figure 5*)

Replace setsu tip when it becomes very soiled. In the monasteries, the usual practice is to replace the tip before sesshin.

SETSU



BASIC SETSU SHAPE

figure 2



CLOTH TIED
WITH THREAD

figure 3



FOLDED CLOTH

figure 4



FINISHED SETSU

figure 5

Cloths

Cloths can be any color, except primary colors. It is best to avoid bright colors and stay with neutral tones. (At Kannon Do, we have used brown, white, and a light blue).

Utensil Holder

This is made of two cloths, the combination finally folded to produce a "barber pole" effect. The colored cloth should be cut to about 21 1/2" x 4 1/8". The white piece is 22 1/8" x 5 1/8".

Place the colored cloth on top of the white cloth. (The edges of the white cloth should extend out about 1/2".) Fold white edges twice, a little over a 1/4" each time. The second time the cloth is folded, it should extend over the raw edges of the colored cloth. Flat hem the two pieces together, using a blind stitch. (See figure 6).

Hint: Ironing first is extremely helpful, not requiring the use of pins until cloths are to be held in place for sewing.

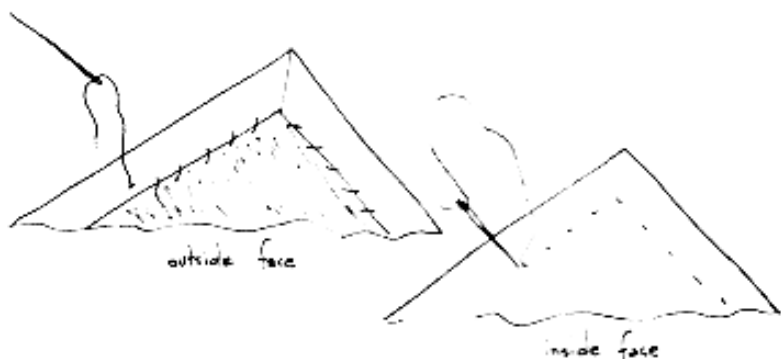
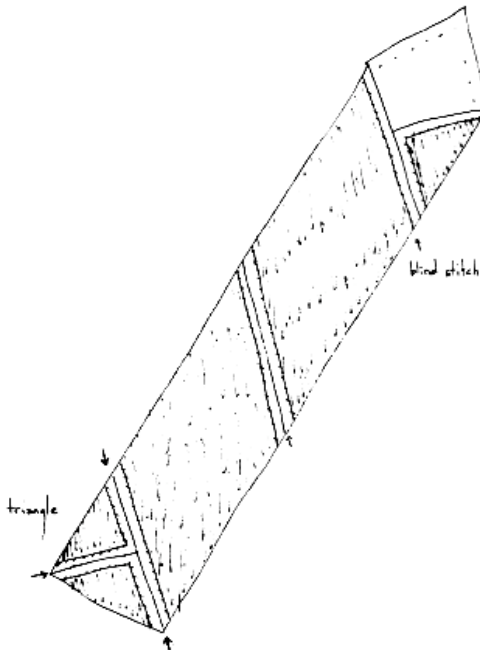

figure 6 HEM STITCHING THE UTENSIL HOLDER

First fold one bottom edge to form a triangle by joining the two corners together. Sew the triangle together down from the middle where the two corners join. (See *figure 7* for position of triangle after cloth is folded) The whole strip of cloth should now have an obelisk shape with one flat end and one pointed end. Now fold the piece diagonally twice into an "envelope" shape. Sew in place with a blind stitch running along the inside of the edges. (See *figure 7*)

figure 7 UTENSIL HOLDER



Napkin

Cut a piece of the colored cloth to 29 1/2" x 14". Fold the edges over twice and blind stitch a flat hem all around. In one corner sew in a small triangle of white material for your name. (See *figure 8*)

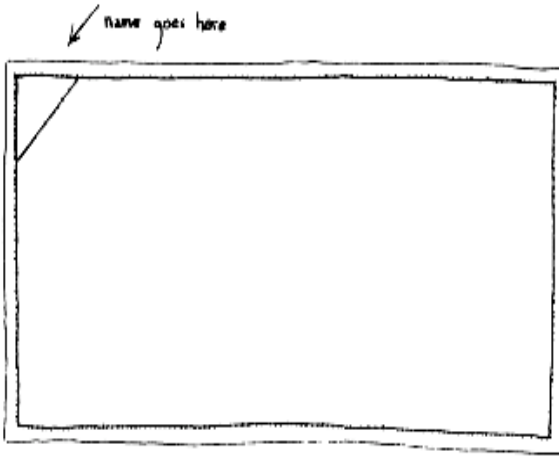

figure 8 UNDERSIDE OF NAPKIN

Drying Cloth

Use absorbent material, such as dish towel cloth, diaper material, or flannel. Cut a 12" x 12" piece, and hem with a blind stitch. It's a good idea to make an extra one of these in case one gets soiled or wet during sesshin.

Bowl Folding Cloth

Use a soft material, such as chambray. Color should be as close to the napkin and utensil holder as possible. Cut to 18" x 18" and flat hem with a blind stitch. If Buddha bowl is larger than described on page 5, increase the size of this cloth accordingly.

USING ORYOKI

BEFORE MEAL

1. Place oryoki directly in front of you with the tied corners of the folding cloth pointing toward your right.
2. Prior to chanting: salt, butter, milk pitchers may be served.

The server will usually bow to two people at a time.

You and the other person will return the bow with gassho.

The person nearest the altar will take the item from the tray. The other person will remain in gassho.

With the first person still holding the item, both gassho to the server who bows in return.

The item is placed between the two, but not on the meal board.

3. After the first chant (See Appendix), open your oryoki.

With two fingers and thumb of the left hand, steady the oryoki from the top. With the right hand, pull the small (almost hidden) corner of the cloth.

Open the cloth and smooth out the left and right corners.

4. Drying Cloth

Pick up the drying cloth with both hands, at the center of left and right edges, respectively.

Fold in half by flipping far side toward you.

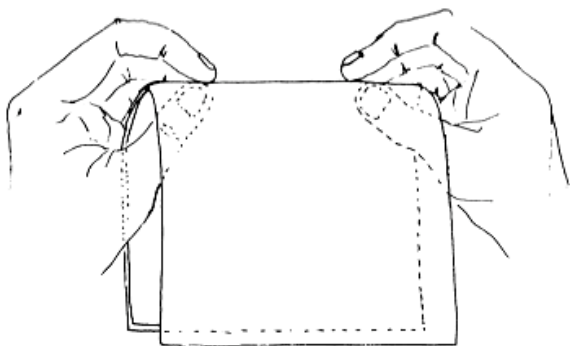

figure 9 FOLDING THE DRYING CLOTH IN HALF

Fold in half the other way (i.e., square it) by bringing together the fingers holding the edges. Hold the hem side in the left hand, folded side in right hand.

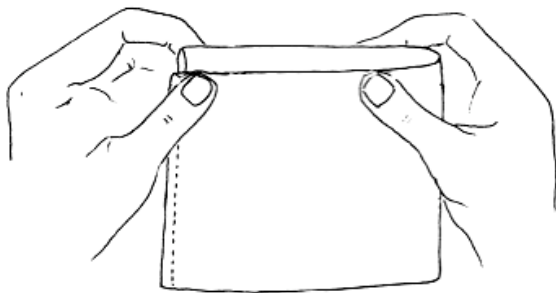

figure 10 SQUARING THE DRYING CLOTH

There should now be four corners at the lower left.

Fold in thirds, bringing right hand over left hand.

Holding top of cloth with two fingers of left hand and bottom with two fingers of right hand, flip the cloth over so that right hand is now on top.

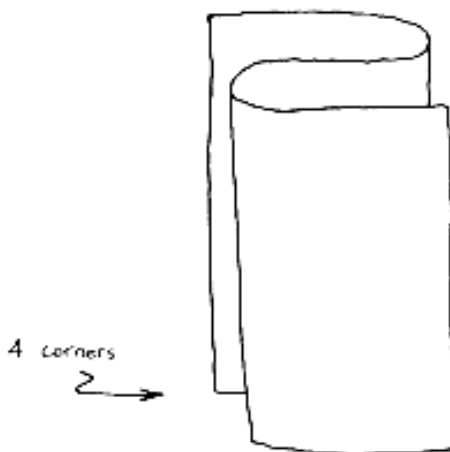

figure 11 FOLDING THE DRYING CLOTH IN THIRDS

Place drying cloth down on utensil holder.
Corners are at upper left.

5. Utensil Holder

Pick up utensil holder and drying cloth together, right hand at top, left hand at bottom. Turn them 90° clockwise and place in front of you (between knees). Corners of the wash cloth will be at the upper right, setu tip will be on the left.

6. Napkin

Two corners of the napkin will be at the upper left on the bowls.

Grasp top corner with right hand.

Grasp bottom corner with left hand.

Pull hands apart, spreading napkin on lap.

7. Folding Cloth

Open the other two corners of the folding cloth: the top one away from you, the other toward you.

Fold the cloth into a star shape in the sequence shown in *figure 12* by folding under a part of each corner but leaving the tips sticking out.

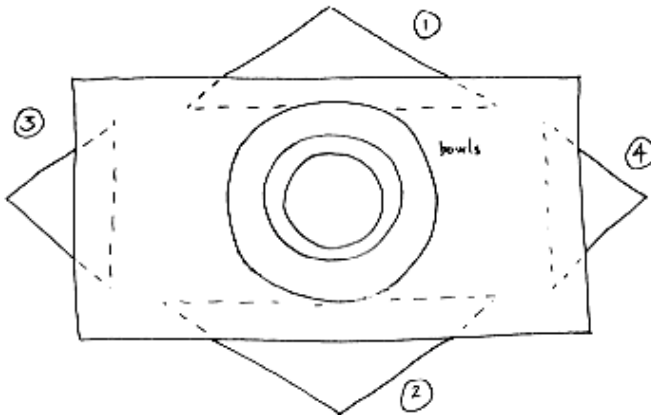

figure 12 CLOTH FOLDED IN STAR SHAPE

8. Bowls

With both hands, pick up entire set of bowls and move them to the left, staying on the cloth.

Take out the smallest bowl and place it on the right.

Put the middle bowl in the center.

(Note: During sesshin, only two bowls are used at the evening meal. In this case, put the middle bowl on top of the small one, as the small one will not be used.)

9. Utensils

Lift up the drying cloth with your right hand, and pick up the utensil holder with your left hand. Put down the drying cloth.

Unfold the utensil holder with two fingers of your right hand.

With the left hand holding the utensil holder against your chest, work out the spoon, sticks and setsu with your right hand. (See *figure 13*) Fold utensil holder in thirds, underneath.

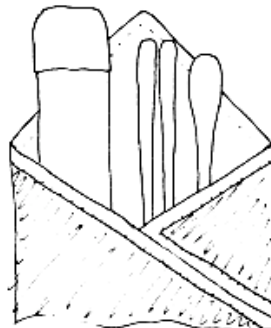

figure 13

UTENSILS IN HOLDER

Remove sticks with your right hand: grasp with first two fingers and thumb from underneath, thumb on right.

Turn hand over and place sticks at the left edge of the cloth, below Buddha bowl, points toward center.

Repeat with spoon, bowl of spoon towards center.

Repeat with setsu, this time first two fingers on top, thumb on bottom. Turn hand over and push setsu toward you between 2nd and 3rd bowls.

(See *figure 14*)

Put utensil holder under drying cloth, opening toward the right.

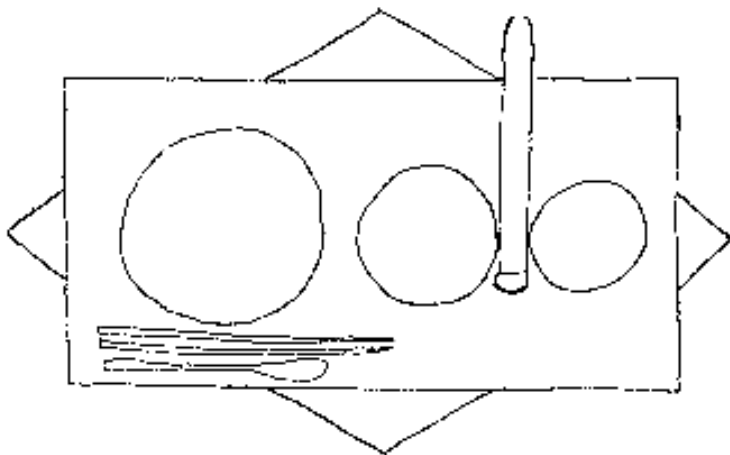

figure 14 UTENSILS AND BOWLS ON FOLDING CLOTH

RECEIVING FOOD

1. Buddha Bowl

Food is served during the second chant. (See Appendix)
Remain in gassho during this chant. If chant ends before you are served, do not stay in gassho.

Two people will be served at a time.

When the server bows, return it with gassho.

Person first in line offers her Buddha bowl; second person remains in gassho.

In accepting a grain dish, you may have to encourage it into your bowl with your spoon, if it is sticky.

To signal that there is enough food in your bowl, turn right palm upward and raise it slightly.

2nd person picks up bowl just before 1st person is finished being served.

After receiving food, if you are the 1st person, put bowl down and wait in gassho. If you are the 2nd person, do not put bowl down, but hold it with both hands (at about waist level) and return gassho when server bows.

2. Middle Bowl

This bowl is usually used for soup or liquid dishes.

(Soup should not be served in the Buddha bowl as the usual way to eat soup is to drink directly from the bowl and the Buddha bowl should not touch the lips.)

Accepting food in the middle bowl is much the same as with the Buddha bowl, with the following exceptions:

Instead of holding the bowl when being served, hand it to the server.

With thumb and two fingers of right hand, grasp the bowl at the top, keeping other two fingers tucked in. (See *figure 15*)

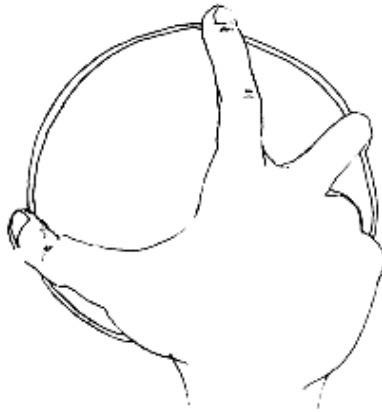

figure 15 GRASPING THE MIDDLE BOWL

Hand the bowl to the server and come to *gassho* during serving.

After indicating enough, receive bowl as in *figure 15*, Put it down and come to *gassho*.

Second person picks up bowl before first person is finished being served. After being served, holds bowl with two hands. Then both bow to server.

3. Small Bowl *same as Middle Bowl*

DURING THE MEAL

1. At the start of the third chant (See Appendix), come to gassho, then to shashu (at the second line of the chant) and bow. Come to zazen posture at the third line.
2. At lunch only, place a small portion of food from the Buddha bowl on the setsu handle at the start of special chant to hungry ghosts. (See Appendix)
3. At the start of the fourth chant, put the spoon in the Buddha bowl and chopsticks across the middle bowl.
4. Come back to gassho. When you reach the fourth line of the fourth chant, starting with "Thus" (See Appendix), pick up the Buddha bowl as shown in *figure 16* and hold it in front of you at eye level.

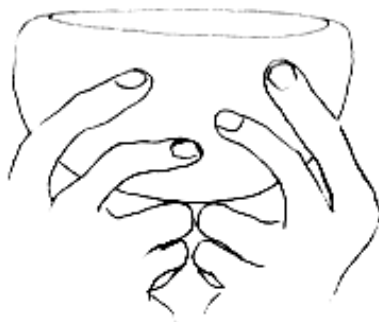

figure 16 HOLDING BUDDHA BOWL

5. At the end of fourth chant, bow with Buddha bowl and begin to eat from it.

Remember: When eating, try to be as quiet as possible. Make no noise with utensils and bowls and try not to make chewing noises.

6. **Using condiments:**

Person nearest the altar uses the side dish first, then passes it to the second person. Second person bows while the first person returns a gassho.

7. When not eating from the Buddha bowl, keep your spoon in it, handle pointing straight ahead.

8. When not using the middle bowl, put chopsticks across it.

9. **Seconds**

When second serving is announced, stop eating and remain in zazen posture.

If you do not want seconds, put the spoon in the Buddha bowl and chopsticks on the middle bowl, tips pointing toward 5 o'clock. Remain in zazen when server passes.

If you do want seconds in the Buddha bowl, put the spoon on the left part of the cloth with bowl of the spoon toward the center, right side up.

For seconds in the middle (or third) bowl, put chopsticks on the cloth, pointing to the center, left to right. If the spoon is also on the cloth, chopsticks are placed between spoon and bowls.

When having seconds, come to gassho as server approaches. Be served as usual.

If you want seconds in the middle bowl, but not in the third bowl, put sticks on the third bowl after second bowl is served. Conversely, if you are not having seconds in the middle bowl, but want it in the third, put sticks on

cloth after server has passed with second bowl.

Be aware of what kind of serving vessel the server used for each bowl. If there is not enough for seconds for the Buddha bowl or middle bowl, you may find yourself being served (or passed by) because something is being served sooner than you thought. So observe what is being served and anticipate what you should do.

At the signal, gassho and begin eating.

AFTER EATING

1. Bowl Cleaning

When finished, put spoon in Buddha bowl and chopsticks on middle bowl. (Do not start cleaning bowls until all have been offered seconds.)

Gassho to your bowls.

Pick up chopsticks in right hand and, covering mouth with left hand, clean off tips quickly in your mouth.

Put sticks on cloth on the right side, tips pointing toward the center.

Pick up setsu with thumb and first finger of right hand, place it in Buddha bowl at the same time taking spoon between second and third fingers. Exchange spoon and setsu.

Clean spoon as with chopsticks and put it down on the right side, bowl down and pointing toward the center.

Pick up Buddha bowl, take setsu in right hand and scrape up food particles. Clean off food morsels in your mouth.

Put down the Buddha bowl and setsu; transfer setsu to middle bowl and clean the bowl.

Repeat for third bowl.

Put third bowl down; put setsu in Buddha bowl, handle pointing straight ahead, and wait in zazen for water to be served.

2. **Bowl Washing**

BUDDHA BOWL

Bow to water server the same as for food serving. Receive water in the same manner as receiving food.

Pick up Buddha bowl and setsu. Hold setsu in right hand at the outside of the bowl, offering the bowl to receive water.

When enough water has been poured, signal by raising setsu slightly.

Put setsu in bowl, handle pointing straight ahead.

Both persons hold bowl with two hands at waist level when bowing to water server.

Hold Buddha bowl in left hand, either resting on left thigh (close to body) or held in front of you. Clean bowl with setsu.

Put setsu in bowl, handle pointing straight ahead. Hold bowl with two hands, holding down setsu with thumbs. Pour water toward you into middle bowl. (If you bring the Buddha bowl as close to you as possible when pouring, there will be less chance of water spilling.)

Holding Buddha bowl in left hand, put setsu in middle bowl.

Pick up drying cloth by grasping the top corner with first and second fingers of right hand. Let it "fall" into a triangular shape.

Place the triangle across Buddha bowl. Using thumb and first finger of both hands, grasp bowl and cloth together, near the rim.

Wipe bowl by turning it clockwise through the cloth.

After a full revolution, hold bowl in left hand and roll up cloth in right hand, leaving about 1" of corner free. Wipe bottom of bowl and leave rolled-up cloth in bowl. Put Buddha bowl down.

UTENSILS

Pick up spoon in right hand with the handle pointing toward you. Put it in your left hand. Pick up setsu with right hand; put bowl of spoon into water in middle bowl and clean it with setsu. Do both sides. Hold spoon straight.

Put setsu in middle bowl, pointing straight out. Put spoon in right hand. With left hand, fold the exposed corner of the drying cloth over the bowl of the spoon without taking the cloth out of the Buddha bowl. Wipe bowl of spoon, turn spoon 180° so bowl is pointing toward you and push it through cloth.

Spoon is now in your right hand, bowl down and pointing left. Without picking up utensil holder, slide spoon into it. (The opening in utensil holder should be on your right, with the fold on the left.)

Repeat steps above with chopsticks.

In left hand pick up folder utensil holder which contains spoon. Slide sticks into utensil holder, toward you. Work utensils to bottom with right hand. Do not let utensils drop of their own weight.

Fold over the utensil holder and replace it in front of you, this time with the opening on the left. The pointed half is on top, with the opening down (not visible). Fold is now on the right.

OTHER BOWLS

Without picking up the middle bowl, hold it with your left hand and wash it with the setsu. Do not lean on arms or elbows.

Put setsu in bowl. Hold bowl and setsu with left hand; lift them up and move small bowl to the middle with your right hand.

With both hands holding middle bowl (thumbs on setsu), pour some water into the small bowl.

Put setsu in small bowl.

Drink remaining water from middle bowl.

Holding middle bowl in left hand, dry it in the same way as the Buddha bowl.

After putting rolled-up drying cloth in middle bowl, put middle bowl inside Buddha bowl, quietly.

Wash small bowl with setsu.

Wash the setsu with water from the small bowl.

With setsu in left hand, dry it with the corner of drying cloth with right thumb and index finger. Push the setsu through the folder over corner held with the thumb and index finger of the right hand. The drying cloth remains in the bowl.

The setsu is in your left hand: two fingers up, thumb under. Twist your wrist and slide the setsu into the utensil holder. Use the right hand to lift up the upper half of the utensil holder to allow setsu to be easily put in.

Sit in zazen until water is collected.

3. Offering Water

When the chant begins (See Appendix), come to gassho. After the chant, return to zazen position until server comes.

Both persons gassho to server. Person nearest altar offers water first.

Pick up small bowl with thumb and two fingers of right hand (if server is on your right; otherwise use left hand). The other two fingers are folded under.

Pour water down side of bucket, pouring toward yourself, using your other hand to cover the bowl. Use a “backhand” motion when pouring, the water going toward your arm. Note that your hand will be bent up. (See *figure 17*)

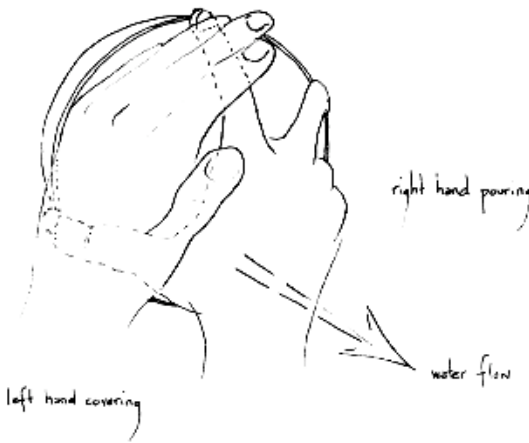

figure 17 OFFERING WATER

Hold bowl with both hands, in lap, until both persons have offered water. Both gassho to server.

Drink remaining drops.

Pick up drying cloth and dry small bowl.

When rolling drying cloth, do not leave an exposed corner. Roll it completely and keep it in the palm of your right hand after drying small bowl.

4. **Closing Oryoki**

Place small bowl into middle bowl, quietly.

With both hands, pick up set of three bowls and move them to the center of folding cloth.

FOLDING CLOTH

Pull out the right and left corners of the folding cloth.

Pull out the corner nearest to you and place it over the top of the bowls with your right hand.

Pull out the corner farthest from you and bring it over the top of the bowls. (See *figure 18*)

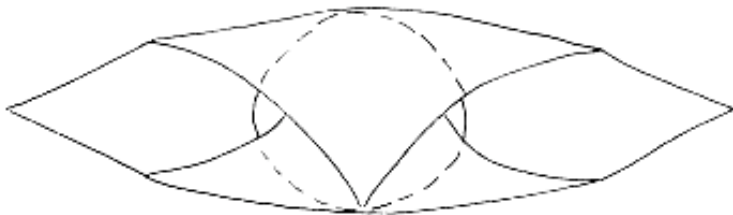

figure 18 PARTIALLY CLOSED ORYOKI

NAPKIN

With thumb and forefinger of left hand, grasp middle of napkin edge nearest you. Thumb is on the bottom.

With the right hand, reach under the napkin and grasp the opposite edge in the same manner.

Bring the far edge under by bringing your right hand toward you. Lift up both hands, causing the napkin to be folded in half. (See *figure 19*)

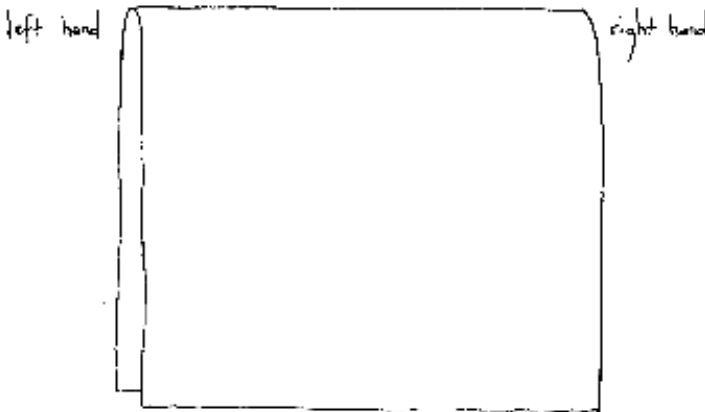

figure 19 NAPKIN FOLDED IN HALF

Fold napkin in thirds, vertically, the right hand being closest to you. (See *figure 20*)

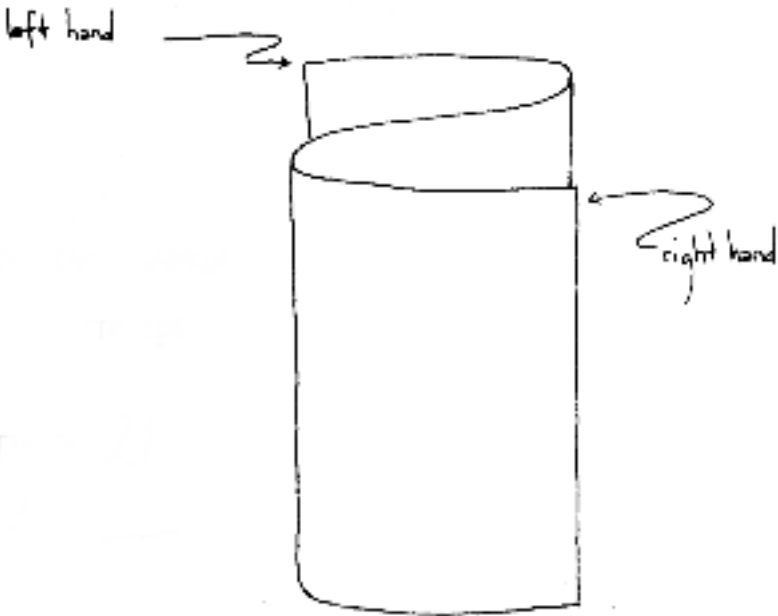

figure 20 FOLDING THE NAPKIN IN THIRDS

Bring right hand down to the center of the napkin and hold it with the thumb and first finger. Hold the top of the napkin with with thumb and first finger of the left hand.

With the left hand, fold napkin in half, toward you. With the left hand now at the bottom, rotate napkin upwards so that the two corners are at the upper left. Place napkin on partially covered bowls. (See figure 21)

(Note: This step was devised to protect the larger napkin used by the relatively long-legged Americans.)

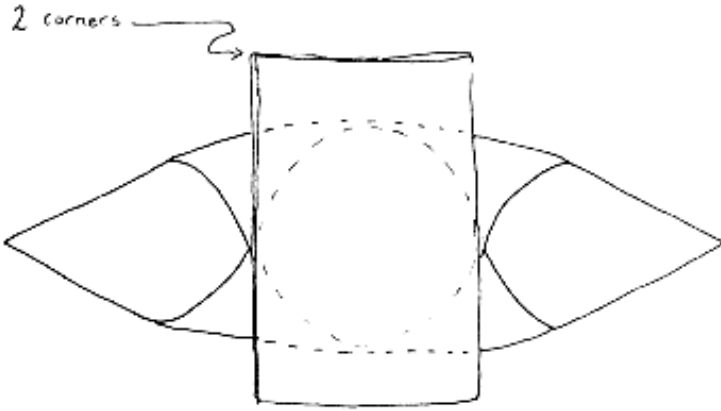

figure 21 NAPKIN ON PARTIALLY COVERED BOWLS

UTENSILS AND DRYING CLOTH

Pick up utensil holder with both hands and place it on top of napkin, tip of setsu pointing toward you.

With right hand, shake drying cloth so that it unrolls. Hold it up, square, in front of you by grasping a corner in each hand.

Straighten top edge by gently tugging between right and left hand. (Do not "snap" cloth.)

Rotate cloth clockwise by bringing left hand to right, dropping the corner held in the right hand, transferring the corner held in the left hand to the right hand, and moving left back to pick up next corner.

Repeat until all four edges have been straightened.

Move hands from corners of the cloth to the middle, letting cloth fold toward you, in half, as in *figure 22*.

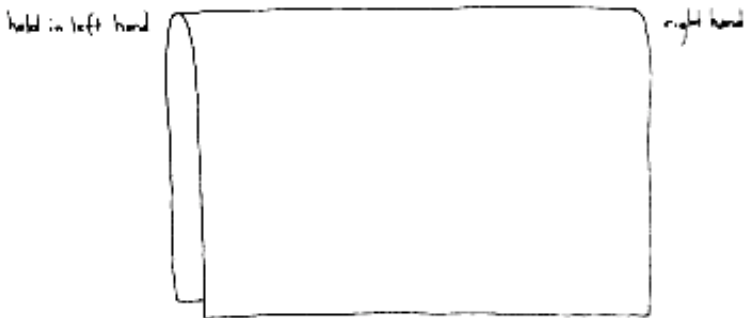

figure 22 DRYING CLOTH FOLDED IN HALF

Place folded drying cloth on utensil holder, center fold across middle, edges at the top.

Unfold cloth by bringing top edge toward you with both hands so that cloth covers utensil holder and most of napkin and bowls, as in *figure 23*.

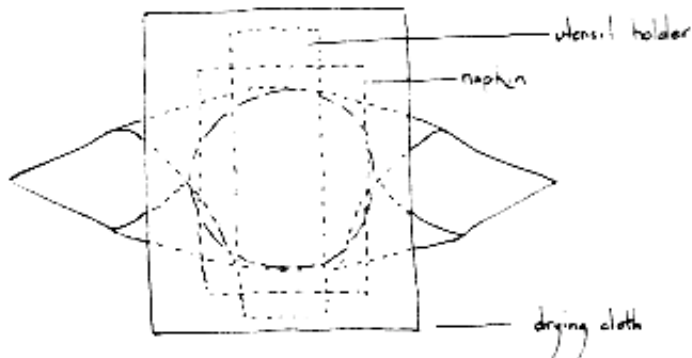

figure 23 DRYING CLOTH ON BOWLS

FOLDING THE CLOTHS

Gassho to oryoki.

Put left hand on top of drying cloth, palm up.
Open thumb and small finger.

With right hand, reach across left hand and pick up left corner of folding cloth. Place it under the left thumb and over the first three fingers of left hand and under the little finger.

Pick up right corner of folding cloth and bring it over folded left corner, placing it between index and middle fingers of left hand. (See *figure 24*)

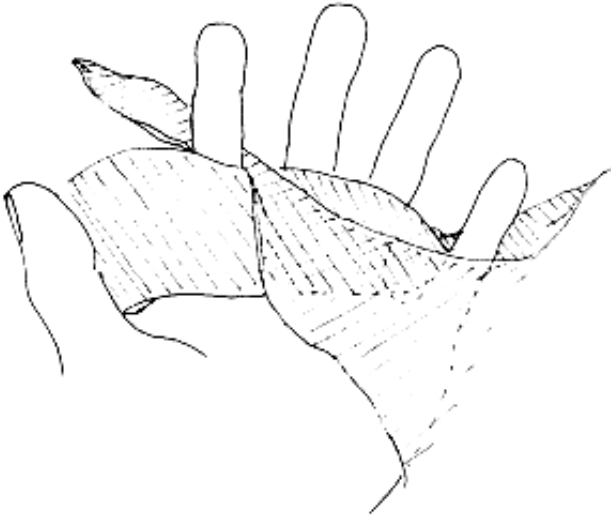

figure 24 FOLDING THE CLOTH

With right hand, hold onto corner that is coming through fourth and last fingers of left hand, at the same releasing grasp of these two fingers.

Pull left hand through (i.e., under) folded cloth, keeping the grasp of index and middle fingers on the corner of the cloth, so that the corner comes under and a "tie" is made.

With the left hand, pick up the corner that was brought under in the last step. Use the thumb and two fingers. Hold corner at base, near the tie.

Take the other corner with the right hand, bring it around (counter clockwise) the corner held in the left hand and tuck it into the index and middle finger of the left hand. (See figure 25)

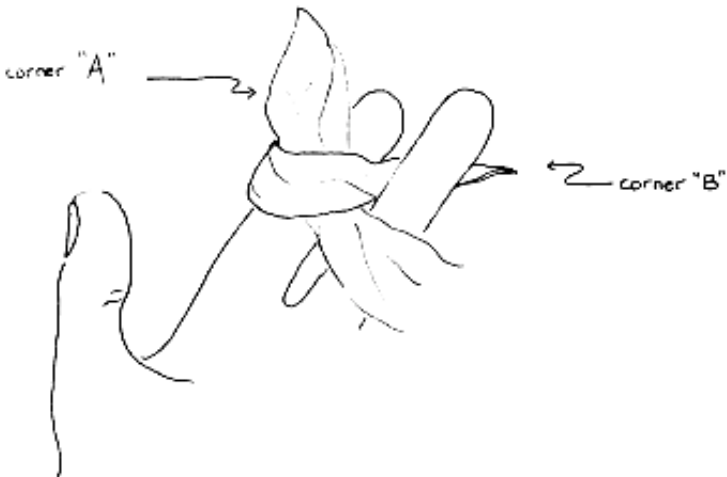

figure 25 TYING THE ORYOKI

With the right hand, grasp the corner not held by the two fingers (corner "A" in *figure 25*).

Draw the left hand through the cloth, bringing corner "B" part way through, so that a tag remains on the right side of the knot that is formed, as shown in *figure 26*.

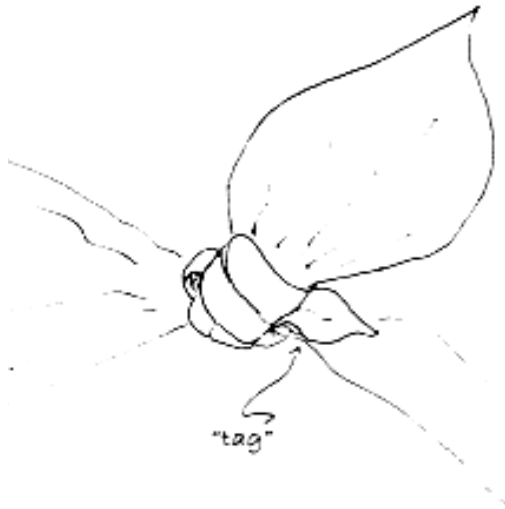

figure 26 FINAL KNOT

Smooth out cloths, gassho to oryoki and wait in zazen posture until last chant ends the meal.

SERVING

The instructions that follow cover only the basic steps required to serve an oryoki meal. Many of the forms used during meal serving are not discussed, since they will vary with the physical circumstances, number of people, as well as the tradition and practice being followed. Some of the forms and procedures not covered here include:

Offering the Buddha tray

Cleaning the Meal Board

Collecting the Hungry Ghost offering

Serving sequence and what route to take when serving

When and how servers bow to each other

When and where to bring food from kitchen to zendo

Planning for emergencies (i.e., should servers carry a towel at the waist in the event of a spill?)

How large should the serving crew be?

When, where, how does the serving crew eat?

What should be done with food while meal is in progress?

What to do with collected Buddha water

When gongs and clappers are used as signals

SERVING PROCEDURES

Always serve the teacher, senior priest, or senior student first, if there is one.

Usually, two people are served at a time. Stand facing them, with the item to be served held a little higher than shoulder height to prevent breathing or sneezing on the food. Bow to them and they will gassho to you.

Turn sideways 45° and kneel on the floor. Turn so that you are partially facing the front of the zendo; in other words, try not to turn your back to the altar. If you are serving the senior priest at the front of the zendo, it is not necessary to turn sideways.

When serving a tray of items, such as tea cups, cookies, salt, or bread, first offer the tray to the person nearest the altar. If it is an item to be served to both (i.e., tea cups) also offer the tray to the second person. Otherwise, after the first person has taken the item (i.e., salt dish), stand up from the kneeling position, turn to face both people, and bow with the tray held at shoulder level.

When serving the food, the Buddha bowl is usually served first with a grain such as cereal or rice. After turning 45° and kneeling, place the serving bowl on the floor or meal board. When the first person offers her bowl, spoon in food until you are given the signal for "enough" (right hand raised slightly, palm up).

If the grain is sticky, the person being served should use his spoon to help remove the grain from the serving ladle into his bowl. If the person being served wants only a small amount, he will signal with the thumb and forefinger of the right hand held in a pinching position.

For the second bowl, the person being served will pick up the bowl and hand it to you. Hold out the thumb and two fingers of your left hand and let the bowl be placed in this cradle. Holding the bowl with the left hand, ladle in the soup (or whatever you are serving) until the signal for enough is given.

The third bowl is served like the second.

When seconds are being served, it is not necessary to stop, bow, and serve everyone. Seconds are served only when an individual has put the spoon (for the Buddha bowl) or the sticks (for the other bowls) down on the oryoki cloth, and is waiting in gassho. These signs indicate a desire for seconds. Stop, bow, and serve as for initial serving.

If an individual does not want seconds, the spoon will be placed in the Buddha bowl and (or) chopsticks will be placed across the second (or) third bowl. This signals no desire for seconds and you should continue walking down the row of students, observing the signs, stopping only when seconds are wanted.

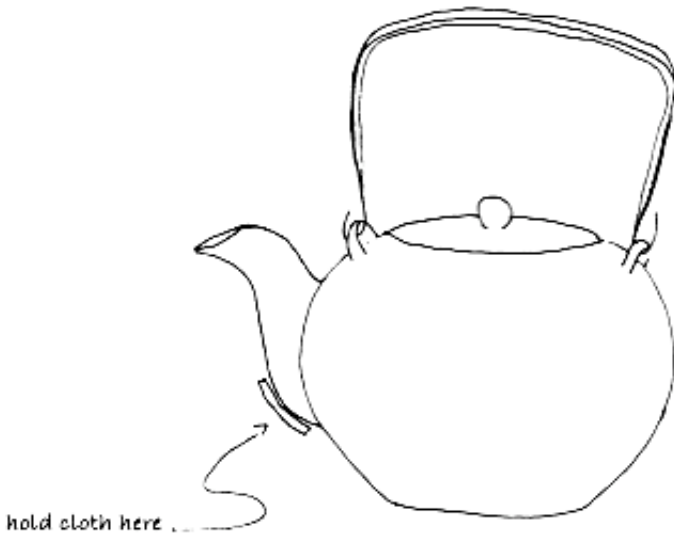

figure 27 POURING WATER

In collecting water, offer the bucket by tilting it slightly forward, so that water can be poured down the side. This will prevent splashing and noise. Use two hands to offer the bucket.

法喜禪悅

APPENDIX

MEAL SUTRAS

Before Meal

All:

Buddha was born at Kapilavatsu
Enlightened at Magadha
Taught at Paranasi
Entered Nirvana at Kusinagara
Now I open Buddha Tathagata's eating bowls
May we be relieved from self-clinging
with all Sentient Beings.

-- open bowls --

Leader:

In the midst of the Three Treasures
With all Sentient Beings
Let us recite the names of Buddha.

All:

Homage to the pure Dharmakaya Vairochana Buddha
the complete Sambhogakaya Vairochana Buddha
the numerous Nirmanakaya Shyakyamuni Buddhas
the future Maitreya Buddha
all Buddhas, past, present, and future

the Mahayana Saddharma Pundarika Sutra
the great Manjusri Bodhisattva
the Mahayana Samantabhadra Bodhisattva
the great compassionate Avalokitesvara Bodhisattva
the many Bodhisattva Mahasattvas
the Maha Prajnaparamita.

Leader (Breakfast):

Rice soup comes from the efforts of all Sentient Beings, past and present, and its ten advantages give us physical and spiritual well-being and promote pure practice.

Leader (Lunch):

We offer this meal of three virtues and six tastes to the Buddha, Dharma, and Sangha and to all the life of the Dharma worlds.

All:

First, seventy-two labors brought us this food; we should know how it comes to us.

Second, as we receive this offering, we should consider whether our virtue and practice deserve it.

Third, as we desire the natural order of mind, to be free from clinging we must be free from greed.

Fourth, to support our life, we take this food.

Fifth, to attain our Way we take this food.

(Lunch Only)

All evil spirits, now I give you this offering; this food will pervade everywhere.

First, this food is for the Three Treasures.

Second, it is for our teachers, parents, nation, and all Sentient Beings.

Third, it is for all beings in the six worlds.

Thus we eat this food with everyone.
We eat to stop all evil
To practice good
To save all Sentient Beings
And to accomplish our Buddha Way.

Bowl Cleaning

All:

The water with which I wash these bowls tastes
like ambrosia.

I offer it to the various spirits to satisfy them.

Om, Makulasai Svaha!

After Meals:

Leader:

May we exist in muddy water with purity like a lotus.

Thus we bow to Buddha.

Kannon Do Zen Meditation Center
1972 Rock Street
Mountain View, CA 94043
www.kannondo.org